

ARMY FM 10-535
AIR FORCE TO 13C7-40-11

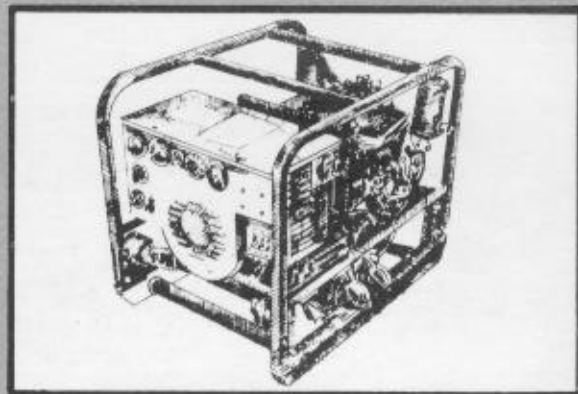

AIRDROP OF SUPPLIES AND EQUIPMENT

RIGGING 5-KILOWATT GENERATOR WITH PORTABLE FLOODLIGHT SET

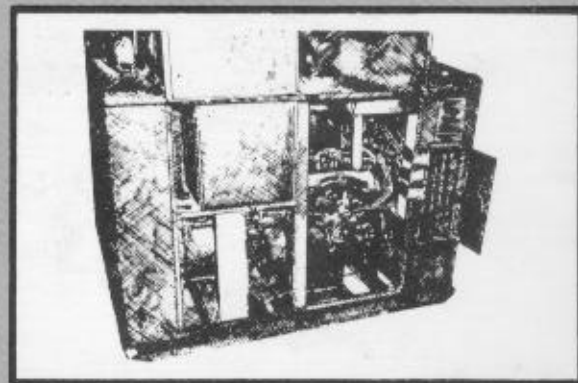

DISTRIBUTION RESTRICTION: This publication contains technical or operational information that is for official government use only. Distribution is limited to US government agencies. Requests from outside the US government for release of this publication under the Freedom of Information Act or the Foreign Military Sales Program must be made to Commander, TRADOC, Fort Monroe, VA 23651-5000.

DEPARTMENTS OF THE ARMY AND THE AIR FORCE



REPLY TO
ATTENTION OF

DEPARTMENT OF THE ARMY
AERIAL DELIVERY AND FIELD SERVICES DEPARTMENT
U.S. ARMY QUARTERMASTER CENTER AND SCHOOL
1010 SHOP ROAD
FORT LEE, VIRGINIA 23801-1502

ATSM-ADFSD

7 October 1998

MEMORANDUM FOR Commander, US Army Training Support Center, ATTN: ATIC-TIST (Mr. Baston), Fort Eustis, VA 23604

SUBJECT: Distribution Restriction Notice on Airdrop Rigging Manuals

1. As proponent for development of all 10-500 series airdrop rigging field manuals and the 10-450 sling load manuals, it has been determined that the distribution restriction on these field manuals should be changed to read: Approved for public release, distribution unlimited.
2. It is requested that unrestricted release of these field manuals be made via the Army Training Digital Library.
3. The new distribution notice will be added to the cover pages as future changes/revisions are made to the manuals.
4. Enclosed you will find a numerical list and the number of changes of the manuals that have unlimited distribution.
5. The point of contact for this action is Mr. Roger Hale, DSN 687-4769.

Encl

THEODORE J. DLUGOS
Director, Aerial Delivery and
Field Services Department

Distribution restrictions for the following Airdrop field manuals should read "**Approved for public release; distribution is unlimited.**"

10-450-3	10-524, c2	10-552, c2
10-450-4	10-526, c3	10-554
10-500-2, c2	10-527, c3	10-555, c2
10-500-3, c1	10-528, c6	10-556
10-500-7, c1	10-529, c1	10-557
10-500-45	10-530	10-558, c1
10-500-53	10-531, c2	10-562
10-500-66, c1	10-532, c4	10-564, c6
10-500-71	10-533	10-567, c1
10-508, c1	10-534, c2	10-569, c1
10-510, c3	10-535	10-571
10-512, c4	10-537, c4	10-572
10-513, c3	10-539, c3	10-573, c1
10-515, c1	10-540, c2	10-574, c4
10-516	10-541, c1	10-575, c2
10-517, c5	10-542, c2	10-576, c1
10-518	10-543, c2	10-577
10-519, c3	10-546	10-579, c2
10-520, c3	10-547, c1	10-584
10-521, c2	10-548, c1	10-586
10-522, c1	10-549	10-588
10-523, c2	10-550, c3	10-591, c1



DEPARTMENT OF THE ARMY

HEADQUARTERS UNITED STATES ARMY TRAINING AND DOCTRINE COMMAND
FORT MONROE, VIRGINIA 23651-5000

REPLY TO
ATTENTION OF

ATCD-SL (70-1f)

21 Oct 96

MEMORANDUM FOR DEPUTY CHIEF OF STAFF OPERATIONS AND PLANS,
400 ARMY PENTAGON, ATTN: DAMO-FDL, WASHINGTON
DC 20310-0400

SUBJECT: Quartermaster (QM) Functional Area Assessment (FAA)
Response

1. References:

a. Message, HQDA, DAMO-FDL, 231825Z Apr 96, subject: QM FAA Results.

b. Memorandum, HQ TRADOC, ATCG, 29 Jul 96, Army Airdrop Capabilities Assessment.

2. At the 29 Mar 96 QM FAA briefing to the Director of Army Staff, the decision was reached to revisit the Army's decision to "shelf" Low Altitude Parachute Extraction System (LAPES) (reference 1a).

a. Reference 1b, solicited CINCs input for their positions on LAPES and assessments of airdrop capabilities. The CINCs responses will be used to chart the direction and role for airdrop in the 21st century.

b. Based on the responses received (enclosure), there is no strong support for LAPES airdrop capability at this time. The consensus for the airdrop capabilities is to continue support for current Low Velocity Airdrop System (LVAD), develop a 500-foot LVAD and further explore Advanced Precision Aerial Delivery System (APADS).

3. Further, we will continue to maintain a range of airdrop capabilities to support all contingencies throughout the Army. The results of the Army Airdrop Capabilities Assessment also will be incorporated into the Operational Concept for Aerial Delivery Operations and Improved Cargo Aerial Delivery Capability Mission Needs Statement being developed by the Quartermaster Directorate of Combat Developments, U.S. Army Combined Arms Support Command (CASCOM).

4. The HQ TRADOC POC is MAJ Higgins, Airborne Airlift Action Office, ATCD-SL, E-mail: higgins@emh10.monroe.army.mil, DSN 680-2469/3921, datafax DSN 680-2520.

ATCD-SL

SUBJECT: Quartermaster (QM) Functional Area Assessment (FAA)
Response

FOR THE DEPUTY CHIEF OF STAFF FOR COMBAT DEVELOPMENTS:

Encl

JOHN A. MANDEVILLE
Colonel, GS
Director, Combat Service Support

CF:

USACASCOM (ATCL-CG/ATCL-QC/ATCL-MES)

USAQMC&S (ATSM-CG/ATSM-ABN/FS)

USANRDEC (SSCNC-UT/AMSSC-PM)

ORGANIZATION	LAPES	LVAD	500' LVAD	APADS	SPTS/ NOT SPEC
USSOCOM		X	X	X	
EUCOM					X
CENTCOM		X	X		
FORSCOM		X	X	X	
TRANSCOM					X
SOUTHCOM	X			X	
VIII ARMY					X
ACOM					X

USSOCOM: Memorandum specifically states that the command does not support LAPES airdrop capability, but supports LVAD as well as APADS.

EUCOM: Draft memorandum specifically states that the command support the need for a low level airdrop capability. However, memorandum summarizes that the specific capability is not important as to have a capability to meet the required mission/threat profile.

CENTCOM: Memorandum specifically states that the command does not support LAPES airdrop capability, but support both current LVAD and 500-foot LVAD airdrop capabilities.

FORSCOM: 1st Endorsement specifically states that the command does not support LAPES airdrop capability, however supports LVAD, 500-foot LVAD and APADS.

TRANSCOM: Memorandum does not specifically address any airdrop capability as it talks to the 21st century requiring the full spectrum of tactical delivery methods.

SOUTHCOM: Memorandum specifically supports LAPES and APADS airdrop capabilities for their command.

VIII ARMY: E-Mail note for VIII Army states that the command has no input to the assessment as their plans call for a limited employment of airdrop.

ACOM: Sent request for input on 30 Sep 96. Received verbal response on 16 Oct 96 stating command is indifferent on the specific capability received.



DEPARTMENT OF THE ARMY
HEADQUARTERS UNITED STATES ARMY TRAINING AND DOCTRINE COMMAND
FORT MONROE, VIRGINIA 23651-3000

REPLY TO
ATTENTION OF

6 SEP 1995

ATCD-SL (70-1f)

MEMORANDUM FOR

Major General Thomas W. Robison, Commander, U.S. Army Combined
Arms Support Command and Fort Lee, Fort Lee, VA 23801-6000
Major General Robert K. Guest, Commander, U.S. Army Quartermaster
Center and School, Fort Lee, VA 23801-5030

SUBJECT: Low Altitude Parachute Extraction System (LAPES)
Disassembly.

1. References:

a. Message, HQ TRADOC, ATCD-SL, 100930Z Jan 95, subject:
LAPES.

b. OVVM Note, HQ USACASCOM, 30 March 95, subject: TRADOC
Disassembly of LAPES.

2. The U.S. Army and other services recently have concurred that
LAPES will be terminated, as this capability is no longer required
as a viable wartime contingency airdrop option. However,
Headquarters, Department of the Army (DA), Deputy Chief of Staff
for Operations and Plans, has agreed that LAPES technology will be
shelved, and all specialized equipment preserved for possible
future use.

3. Take the necessary steps to terminate training and leader
development concerning LAPES operations. Major General Guest's
questions regarding the disassembly of LAPES (enclosed) with
following guidance will be utilized:

a. "Does the U.S. Army Quartermaster Center and School
(USAQMC&S) continue to publish LAPES procedures in their joint
field manual (FMs)/technical order manuals?" "Do we publish the
LAPES procedures that have been written but not been printed yet?"
Publishing LAPES procedures in all joint publications, Army FMs,
regulations, etc., will be discontinued and addressed in the next
revision of the aforementioned documents. Concurrently, all LAPES
procedures that have been written and not printed will not be
published.

6 SEP 1995

ATCD-SL
SUBJECT: Low Altitude Parachute Extraction System (LAPES)
Disassembly

b. "Do we keep LAPES in our programs of instruction (POIs)?"
"Do we teach LAPES to other services and our allies?" The
USAQMC&S will remove LAPES procedures from PCI and cease teaching
LAPES to other services and/or allies.

c. "What do we teach to folks that have LAPES equipment in
their war reserves?" All instruction concerning LAPES procedures
will be discontinued whether LAPES equipment is located in units
or in war reserves.

d. "What is the DA/TRADOC guidance on disposition of unit,
depot, and war reserves LAPES equipment?" All LAPES equipment in
war reserves and depot should be preserved with the exception of a
few items that can be utilized in other existing airdrop capabili-
ties. Specifically, the Type V airdrop platforms and attitude
control bars of the LAPES system are being utilized to augment
current Low Velocity Airdrop Systems (LVADS) loads.

e. "What is the guidance to U.S. Army Test and Experimenta-
tion Command on force development test and experimentation certi-
fication of LAPES loads?" The certification of all LAPES loads at
the Airborne Special Operations Test Directorate will be
redirected toward testing and certification of LVADS loads.

4. HQ TRADOC POC is CPT Higgins or CPT Phillips, ATCD-SL, DSN
680-2469/3921, datafax DSN 680-2520.

FOR THE COMMANDER:

Encl

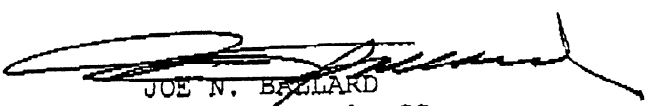

JOE N. BALLARD
Major General, GS
Chief of Staff

CF:
HQDA (DAMO-FDL)
CDR, NRDEC (SAFNC-UA)
CDR, FORSCOM (FCJ3-FC)
CDR, OPTEC (CSTE-CS, CSTE-OPM)
CDR, ATCOM (AMSAT-W-TD)
DIR, ABNSOTD (ATCT-AB)
HQ TRADOC (ATCD-L, ATCD-RM, ATDO-A, ATTG-IT)

Date and time 07/18/95 10:28:11

From: HIGGINSN--MON1
To: HIGGINSN--MON1

From: OPT NEIL HIGGINS, (AAACO), 680-2469
Subject: TRADOC "DISASSEMBLY" OF LAPES

* AIRBORNE AIRLIFT ACTION OFFICE *
* (AAACO) *

** Forwarding note from BRUNEAUN--OMSNAMES 07/18/95 10:27 ***
Received: from LEE-EMH2.ARMY.MIL by MONROE-EMH2.ARMY.MIL (IBM VM SMTP V2R2)
with TOP; Tue, 18 Jul 95 10:27:22 EDT
Received: from LEE1 by LEE-EMH2.ARMY.MIL (IBM VM SMTP V2R2) with SMTP id 3547;
Tue, 18 Jul 95 10:29:34 EDT
Comments: Converted from PROFS to RFC822 format by PUMP V2.2X
Date: Tue, 18 Jul 95 10:29:26 EDT
From: NORMAN BRUNEAU <BRUNEAUN@LEE-EMH2.ARMY.MIL>
Subject: TRADOC "DISASSEMBLY" OF LAPES
To: "NEIL HIGGINS- AAACO " <HIGGIN@MONROE-EMH1.ARMY.MIL>

** Resending note of 06/30/95 09:23

From: LARRY MC MILLIAN AAA <MCMILLI@MONROE-EMH1.ARMY.MIL>
To: NORMAN BRUNEAU
Subject: TRADOC "DISASSEMBLY" OF LAPES

NEIL- HERE ARE THE QUESTIONS THAT MG GUEST WANTS DA/ TRADOC TO ANSWER RE LAPES, AS I UNDERSTAND HIS GUIDANCE. I HAVE DISCUSSED THESE W/ OUR ABN DPT. IF THESE QUESTIONS MAKE SENSE, GIVE ME AN "UP" BEFORE I FORMALLY SEND ANYTHING OUT. MG GUEST WANTS SPECIFIC GUIDANCE FM TRADOC ON LAPES, RESPONSE NEEDS TO BE CLEAR AND TO THE POINT. A LOT OF THIS WILL HINGE ON WHAT ACC PLANS TO DO W/ LAPES NOW THAT THE AIR STAFF HAS GIVEN THEM THE GREEN LIGHT TO KILL IT. IF THEY PLAN TO PLACE IT ON THE SHELF OR KEEP A LIMITED OR CONTINGENCY CAPABILITY, THAT WILL DRIVE YOUR ANSWER TO US, AT THIS POINT I THINK ACC WILL DO WHATEVER THE ARMY WANTS, AS THEIR PRIMARY CUSTOMER. I WILL NOT REHASH HOW THE ARMY DECIDED THEY DIDNT NEED LAPES. QUESTIONS FOLLOW:

- DOES THE GMS CONTINUE TO PUBLISH LAPES PROCEDURES IN THEIR JOINT FM/TO MANUALS?
- DO WE PUBLISH THE LAPES PROCEDURES THAT HAVE BEEN WRITTEN BUT HAVE NOT BEEN PRINTED YET?
- DO WE REMOVE ALL LAPES PROCEDURES FROM ALREADY PUBLISHED MANUALS?
- DO WE KEEP LAPES IN OUR POI?
- DO WE TEACH LAPES TO OTHER SERVICES AND OUR ALLIES?
- WHAT DO WE TEACH TO FOLKS THAT HAVE LAPES EQUIPMENT IN THEIR WAR RESERVES?
- WHAT IS THE DA/TRADOC GUIDANCE ON DISPOSITION OF UNIT, DEPOT, AND WAR RESERVE LAPES EQUIPMENT?
- WHAT IS THE GUIDANCE TO TEXCOM ON THE FUTE CERTIFICATION OF LAPES LOADS?

I KNOW THESE ARE TOUGH QUESTIONS, BUT THEY HAVE TO BE ASKED. HQ STAFFS CANNOT SIMPLY SAY "KILL IT" AND MOVE ON TO THE NEXT ISSUE. I DONT THINK WE ARE DOING OUR JOB IF WE LEAVE IT UP TO THE SCHOOLHOUSE TO INTERPRET SKETCHY GUIDANCE. THAT PLACES US IN THE POSSIBLE POSITION OF BEING ACCUSED OF NOT FOLLOWING ORDERS.

LETS TALK.....NORM

TRK 2/47

SEP 11 11 08:30AM CSSRD FT MONROE VA 66 11

DEPARTMENT OF THE ARMY
QUARTERMASTER CENTER AND SCHOOL
1201 22D STREET
FORT LEE, VIRGINIA 23801-1601

ATSM-ABN-FS

15 Dec 96

MEMORANDUM FOR RECORD

SUBJECT: Airdrop Equipment Update

Reference:

- a. Phone conversation between CW4 Mahon, CASCOM and Dick Harper, Weapons System Management Office, Army Aviation Troop Command. Subject : sab
- b. Phone conversation between CW4 Mahon, CASCOM and Don Stump, Logistics Management Specialist, Office, Deputy Chief of Staff for Logistics. Subject. sab
- c. Phone conversation between CW4 Mahon, CASCOM and Chief Msgt Okraneck, Hqrs Air Combat Command. Subject sab
- d. msg dtg R 181348Z Feb 94. subject: FCIF item: Type II platforms, PEFTC and SL/CS for Air Force unilateral training

1. Based on information received from the references a-c above, the following update is provided per request ref c, above.

- a. The type II modular platform no longer exists within any contingency stocks. Therefore, maintaining Joint Inspection training program is no longer required for this equipment.
- b. The Parachute Extraction Transfer Force Coupling (PEFTC) no longer exists within any contingency stocks. Therefore, maintaining Joint Inspection training program is no longer required for this equipment.
- c. The metric platform interim rigging procedures are no longer valid as they apply to metric platforms. Those rigging procedures which have dual application with the type V platform are still valid for the type V platform.
- d. The static line connector strap (SL/CS) currently has limited application. Only those loads that specifically require this system are authorized use of this system. The SL/CS is not an across the board substitute for the Extraction Force Transfer Coupling (EFTC). These authorized loads are specific in nature and will normally be found in the special operations arena of airdrop loads. This system is not authorized for use IAW ref d, above.

2. For additional questions/information contact the undersigned at DSN 687-4733, Fax 3084.

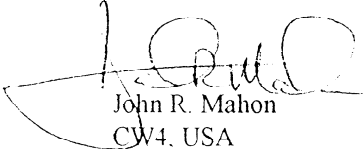
John R. Mahon
CW4, USA
Senior Airdrop Systems
Technician

**FIELD MANUAL
No 10-535
TECHNICAL ORDER
No 13C7-40-11**

**HEADQUARTERS
DEPARTMENTS OF THE ARMY
AND THE AIR FORCE
Washington, DC, 14 November 1985**

**AIRDROP OF SUPPLIES AND EQUIPMENT
RIGGING 5-KILOWATT GENERATOR SET WITH
PORTABLE FLOODLIGHT SET**

TABLE OF CONTENTS

	Paragraph	Page
PREFACE		iii
CHAPTER 1. INTRODUCTION		
Description of Items	1-1	1-1
Special Considerations	1-2	1-2
CHAPTER 2. RIGGING GENERATOR AND FLOODLIGHT SET FOR LOW-VELOCITY AIRDROP		
Description of Load	2-1	2-1
Preparing Platform	2-2	2-1
Building and Placing Honeycomb Stacks	2-3	2-3
Preparing Generator Set	2-4	2-4
Preparing Floodlight Set	2-5	2-7
Positioning Generator and Floodlight Set	2-6	2-8
Positioning Accompanying Load	2-7	2-8
Installing Lashings	2-8	2-9
Installing Deadman's Tie	2-9	2-11
Stowing Cargo Parachute	2-10	2-11
Installing Extraction System	2-11	2-12
Installing Release System	2-12	2-13
Positioning Extraction Parachute	2-13	2-14
Marking Rigged Load	2-14	2-14
Equipment Required	2-15	2-15

***This manual supersedes FM 10-535/TO 13C7-40-11, 1 March 1979.**

FM 10-535/TO 13C7-40-11

	Paragraph	Page
CHAPTER 3. RIGGING GENERATOR AND FLOODLIGHT SET FOR LAPE AIRDROP		
Description of Load	3-1	3-1
Preparing Platform	3-2	3-2
Building and Placing Honeycomb Stacks	3-3	3-3
Preparing Floodlight Set	3-4	3-4
Preparing Generator Set	3-5	3-5
Stowing and Lashing Load	3-6	3-8
Installing ACB	3-7	3-18
Installing Extraction System	3-8	3-19
Positioning Extraction Parachutes	3-9	3-20
Marking Rigged Load	3-10	3-20
Equipment Required	3-11	3-21
GLOSSARY		Glossary-1
REFERENCES		References-1

PREFACE

SCOPE

This manual tells and shows how to rig the 5-kilowatt generator set with portable floodlight set and accompanying load for low-velocity airdrop from a C-130 or C-141 aircraft. In addition, it tells and shows how to rig the 5-kilowatt generator set with portable floodlight set and accompanying load for LAPE airdrop from a C-130 aircraft. This manual is designed for use by all parachute riggers.

USER INFORMATION

The proponent of this publication is HQ TRADOC. You are encouraged to report any errors or omissions and to suggest ways of making this a better manual. Army personnel, send your comments on DA Form 2028 (Recommended Changes to Publications and Blank Forms) directly to:

Commandant
US Army Quartermaster School
ATTN: ATSM-DTL
Fort Lee, VA 23801-5036

Air Force personnel, send your reports on AFTO Form 22 (Technical Order Publication Improvement Report) through:

Headquarters
Military Airlift Command
(MAC/DOXT)
Scott AFB, IL 62225-5001

to:

Commandant
US Army Quartermaster School
ATTN: ATSM-DTL
Fort Lee, VA 23801-5036

Also send information copies of AFTO Form 22 to:

San Antonio ALC/MMEDTR
Kelly AFB, TX 78241-5000

CHAPTER 1

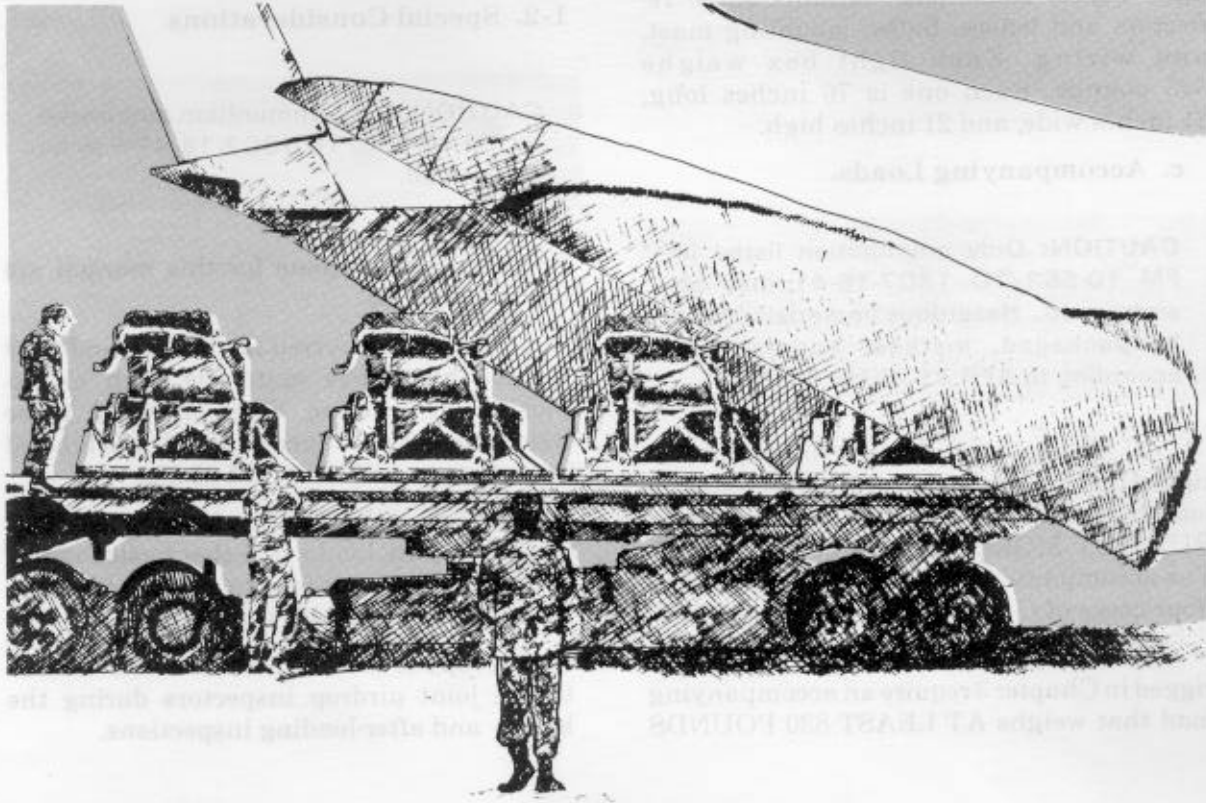
INTRODUCTION**1-1. Description of Items**

The description of the items covered in this manual is as follows:

a. Generators.

(1) The unrigged Hol-Gar Model CE-55-AC/WK6, 5-kilowatt, 60-cycle, gasoline-engine-driven, water-cooled generator set (rigged in Chapter 2) weighs 1,020 pounds. It is 56 inches long, 26 inches wide, and 43 inches high.

(2) The unrigged Model MEP 017A, 5-kilowatt, 60-cycle, gasoline-engine-driven, air-cooled generator set (rigged in Chapter 3) weighs 479 pounds. It is 40 inches long, 30 inches wide, and 25 inches high.

Note: The procedures in this manual may be adapted for rigging the following similar generators:

Air-cooled

Model MEP-022A

Water-cooled

Hol-Gar Model CE-52M-AC

Hol-Gar Model CE-56-ACC

Hol-Gar Model CE-400-AC

International Fermont Model J117

Onan Model 5GF-8SR/3100

Onan Model 5GFE-408XR/3101A

b. Floodlight Set. The portable, electric, mast-mounted floodlight set (rigged in Chapters 2 and 3) consists of two groups of floodlights and equipment stowed in two light boxes. Each box contains three reflectors and lenses, bulbs, mounting mast, and wiring. Each light box weighs 345 pounds. Each one is 76 inches long, 21 inches wide, and 21 inches high.

c. Accompanying Loads.

CAUTION: Only ammunition listed in FM 10-553/TO 13C7-18-41 may be airdropped. Hazardous materials must be packaged, marked, and labeled according to AFR 71-4/TM 38-250.

(1) The generator and floodlight set rigged in Chapter 2 require an accompanying load that weighs AT LEAST 100 POUNDS BUT NOT MORE THAN 1,290 POUNDS. The accompanying load shown in Chapter 2 (four cases of C-rations) weighs 100 pounds.

(2) The generator and floodlight set rigged in Chapter 3 require an accompanying load that weighs AT LEAST 830 POUNDS

BUT NOT MORE THAN 7,050 POUNDS. The accompanying load shown in Chapter 3 (56 cases of C-rations) weighs 1,400 pounds.

1-2. Special Considerations

CAUTION: Only ammunition authorized by FM 10-553/TO 13C7-18-41 may be airdropped.

Special considerations for this manual are described below.

a. The loads covered in this manual may include hazardous materials such as explosives or gasoline. When included, these items must be packaged, marked, and labeled according to AFR 71-4/TM 38-250.

b. The floodlight set can be dropped as an accompanying load with other basic loads if it meets the requirements and restrictions outlined in FM 10-500/TO 13C7-1-5.

c. A copy of this manual must be available to the joint airdrop inspectors during the before- and after-loading inspections.

CHAPTER 2

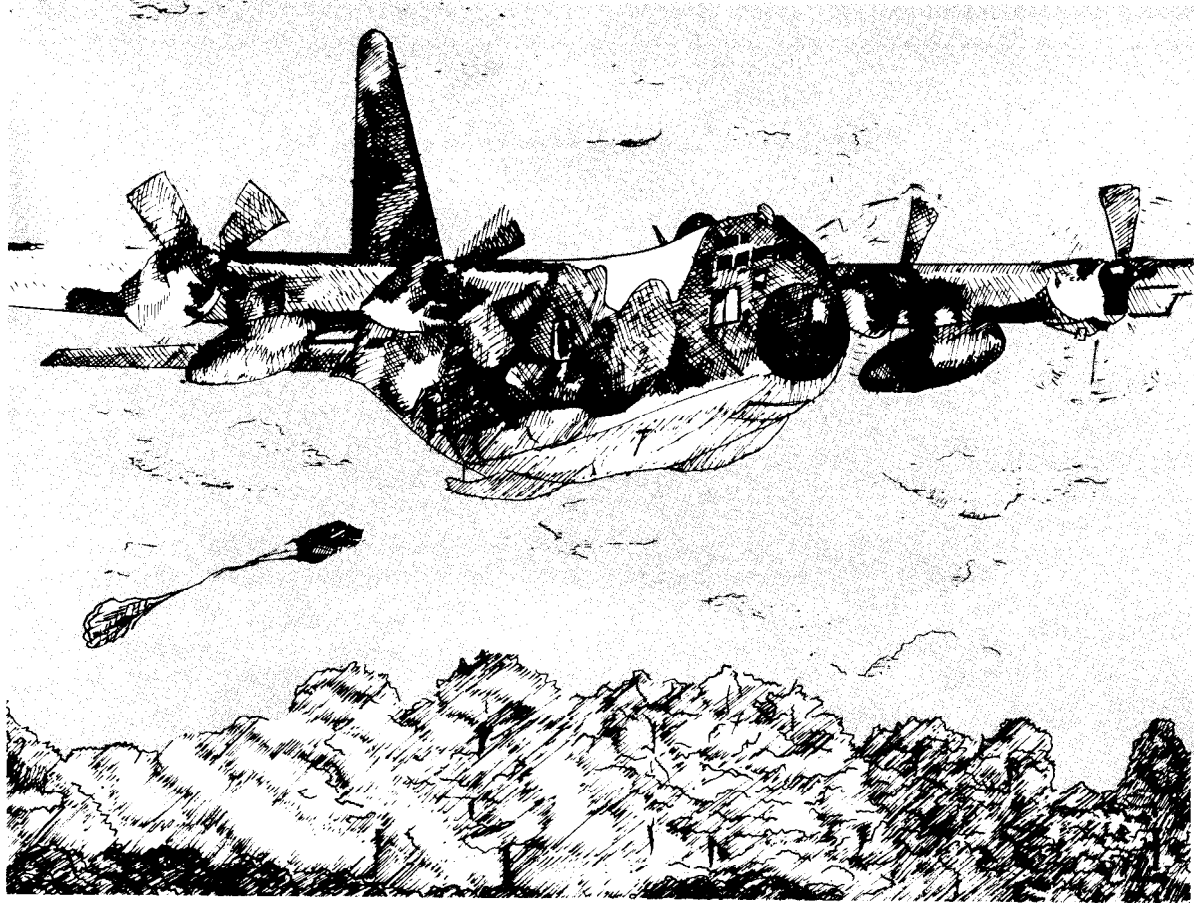
**RIGGING GENERATOR AND FLOODLIGHT SET
FOR LOW-VELOCITY AIRDROP****2-1. Description of Load**

The 5-kilowatt, 60-cycle, gasoline-engine driven, water-cooled generator set and the electric floodlight set (two light boxes containing six floodlights), with accompanying load, are rigged on an 8-foot, type II, modular platform for low-velocity airdrop. The load requires one G-11A or G-11B cargo parachute and other items of airdrop equipment. The generator and the floodlight set shown in this chapter are rigged with four cases of

C-rations as an accompanying load. This load can be dropped by low-velocity airdrop from the C-130 or C-141 aircraft.

2-2. Preparing Platform

Prepare the platform as follows:

a. Inspecting Platform. Inspect, or assemble and inspect, the platform as outlined in TM 10-1670-208-20&P/TO 13C3-4-12.

b. Attaching Suspension Slings. Attach four 3-foot and four 9-foot slings to the platform as shown in Figure 2-1.

c. Attaching and Numbering Clevises. Attach eight load tiedown clevises as shown

in Figure 2-1. Number the clevises as shown in Figure 2-1.

d. Positioning Load Spreaders. Position two plywood load spreaders on the platform as shown in Figure 2-1.

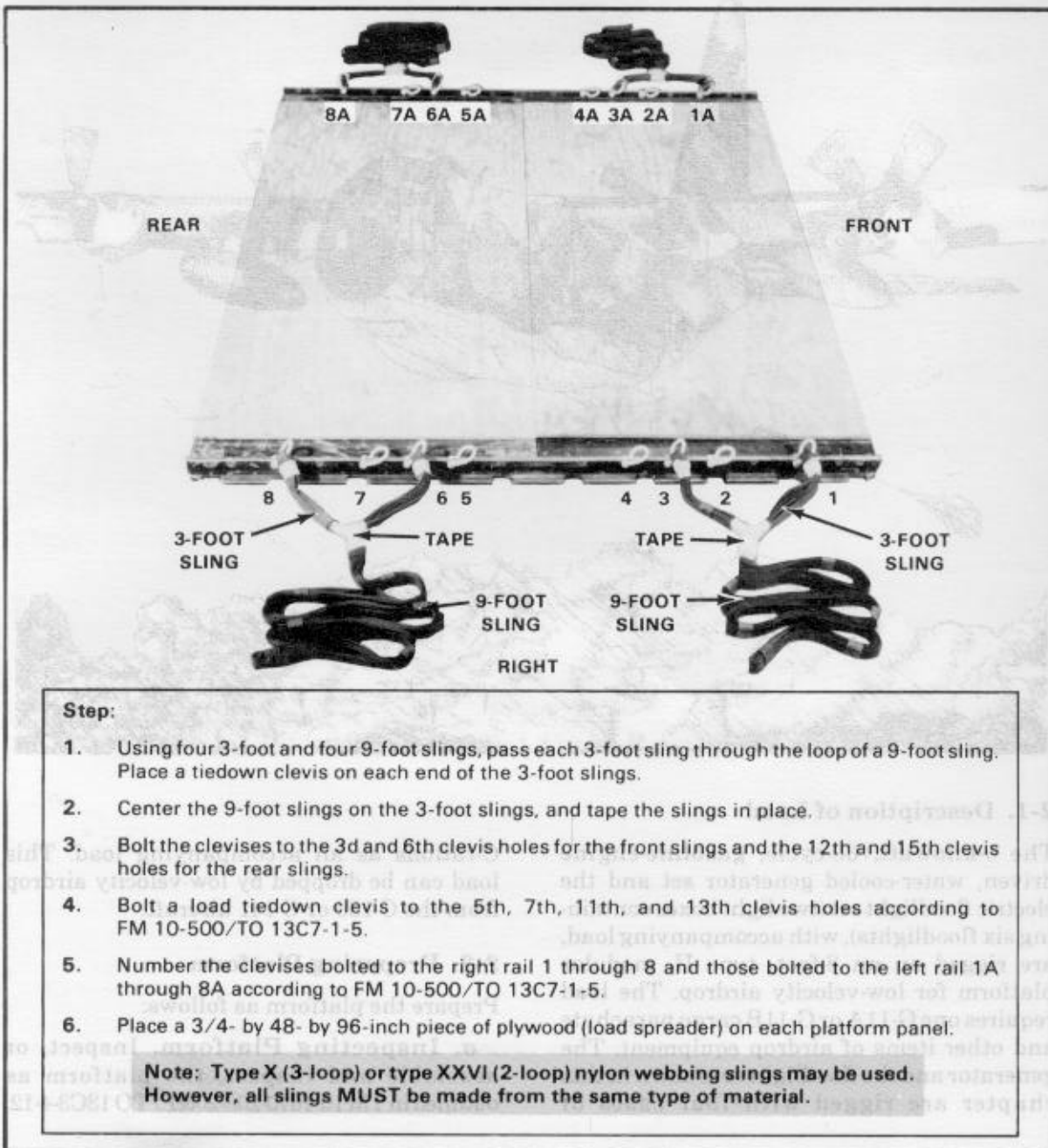

Figure 2-1. Platform prepared

2-3. Building and Placing Honeycomb Stacks

Build the honeycomb stacks according to FM 10-500/TO 13C7-1-5, using the

information in Figure 2-2. Place the stacks on the platform as shown in Figure 2-2.

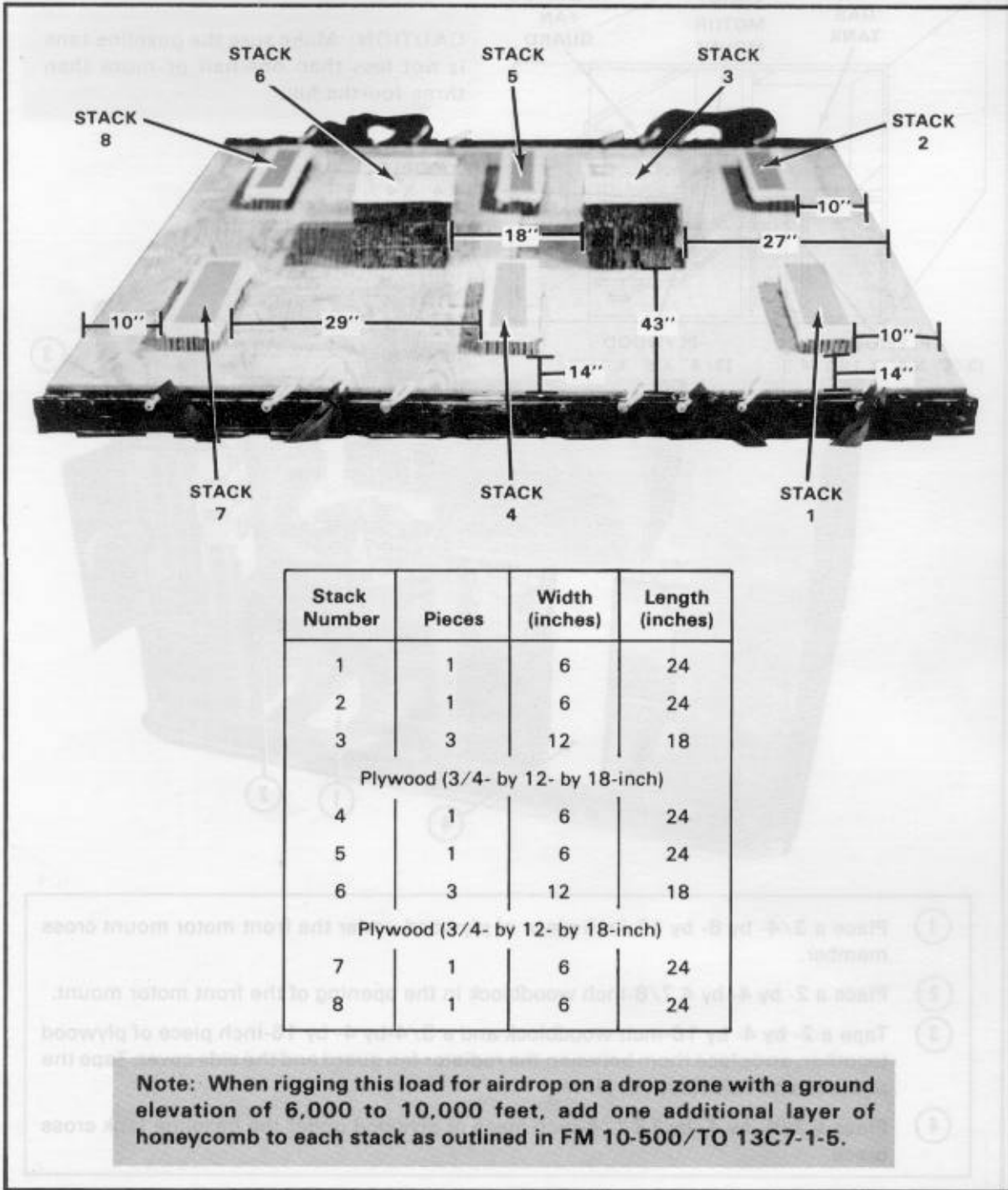

Figure 2-2. Honeycomb stacks prepared and positioned

2-4. Preparing Generator Set

Prepare the generator set as shown in Figures 2-3 through 2-5.

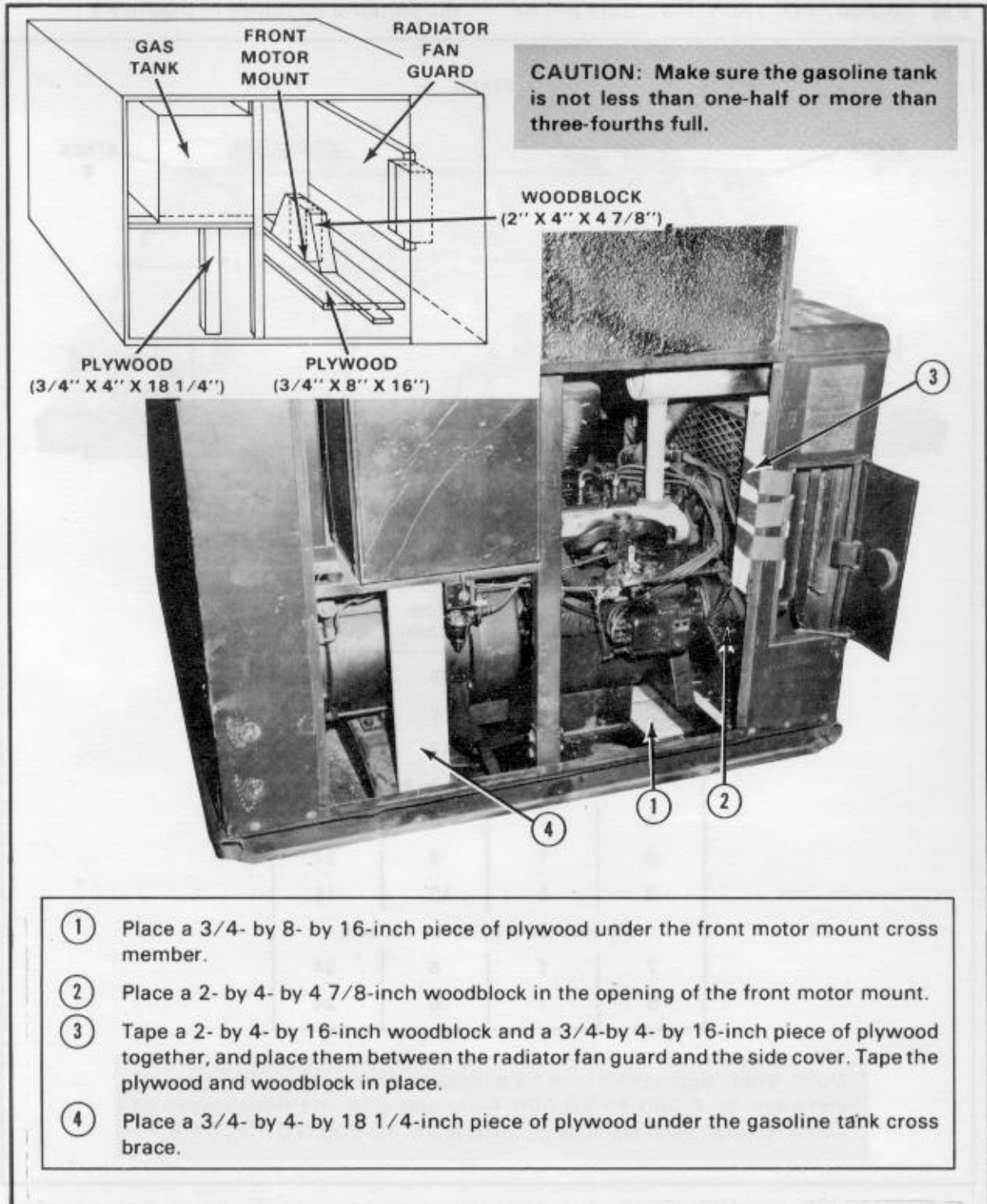

Figure 2-3. Front of generator prepared

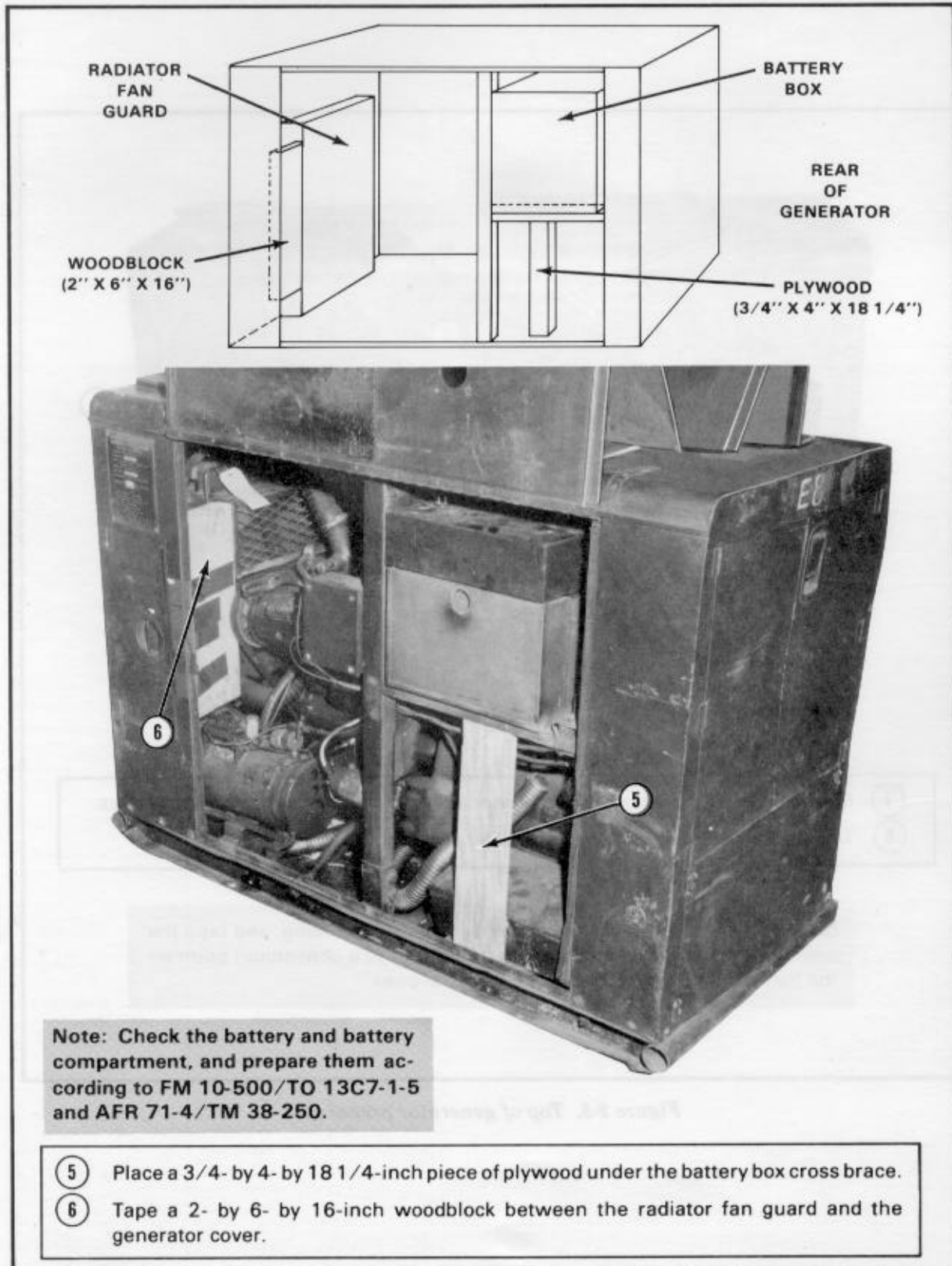

Figure 2-4. Rear of generator prepared

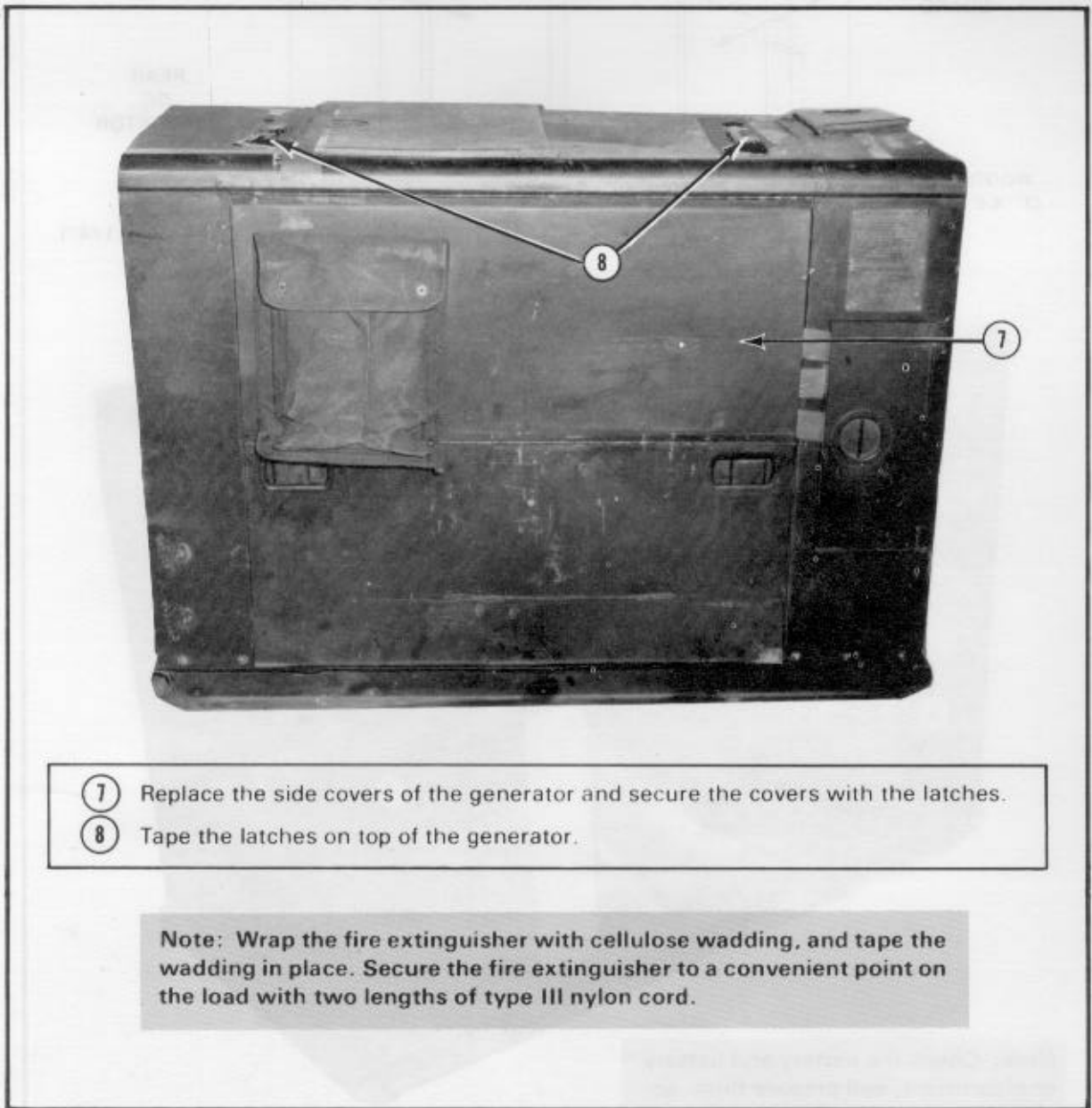

Figure 2-5. Top of generator prepared

2-5. Preparing Floodlight Set

Prepare the floodlight set as shown in Figure 2-6.

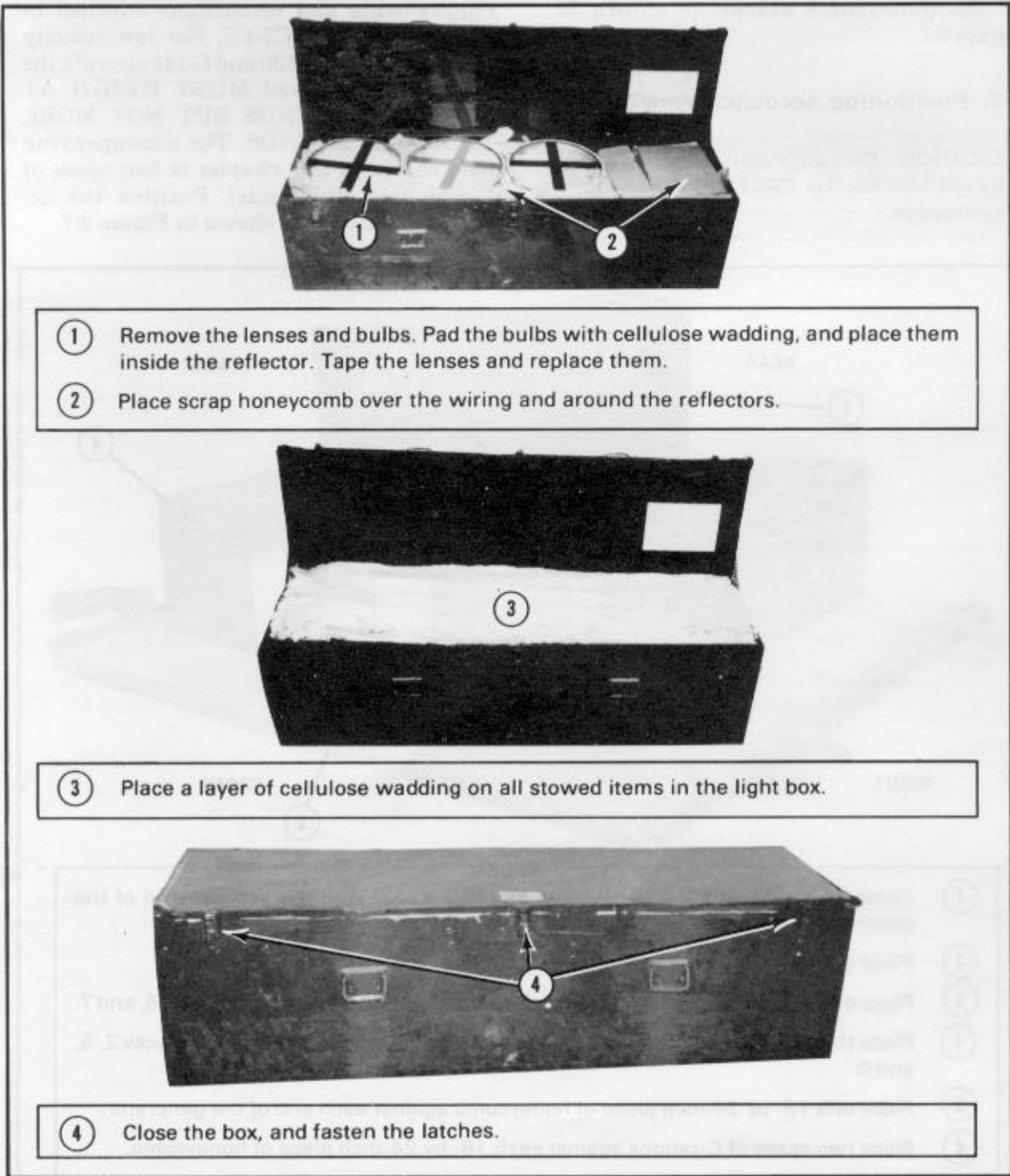

Figure 2-6. Light box prepared

2-6. Positioning Generator and Floodlight Set

Position the generator and the floodlight set on the honeycomb stacks as shown in Figure 2-7.

2-7. Positioning Accompanying Load

CAUTION: Only ammunition authorized by FM 10-553/TO 13C7-18-41 may be airdropped.

The accompanying load must meet the requirements and restrictions outlined in FM 10-500/TO 13C7-1-5. For low-velocity airdrop from the C-130 and C-141 aircraft, the accompanying load **MUST WEIGH AT LEAST 100 POUNDS BUT NOT MORE THAN 1,290 POUNDS**. The accompanying load shown in this chapter is four cases of C-rations (100 pounds). Position the accompanying load as shown in Figure 2-7.

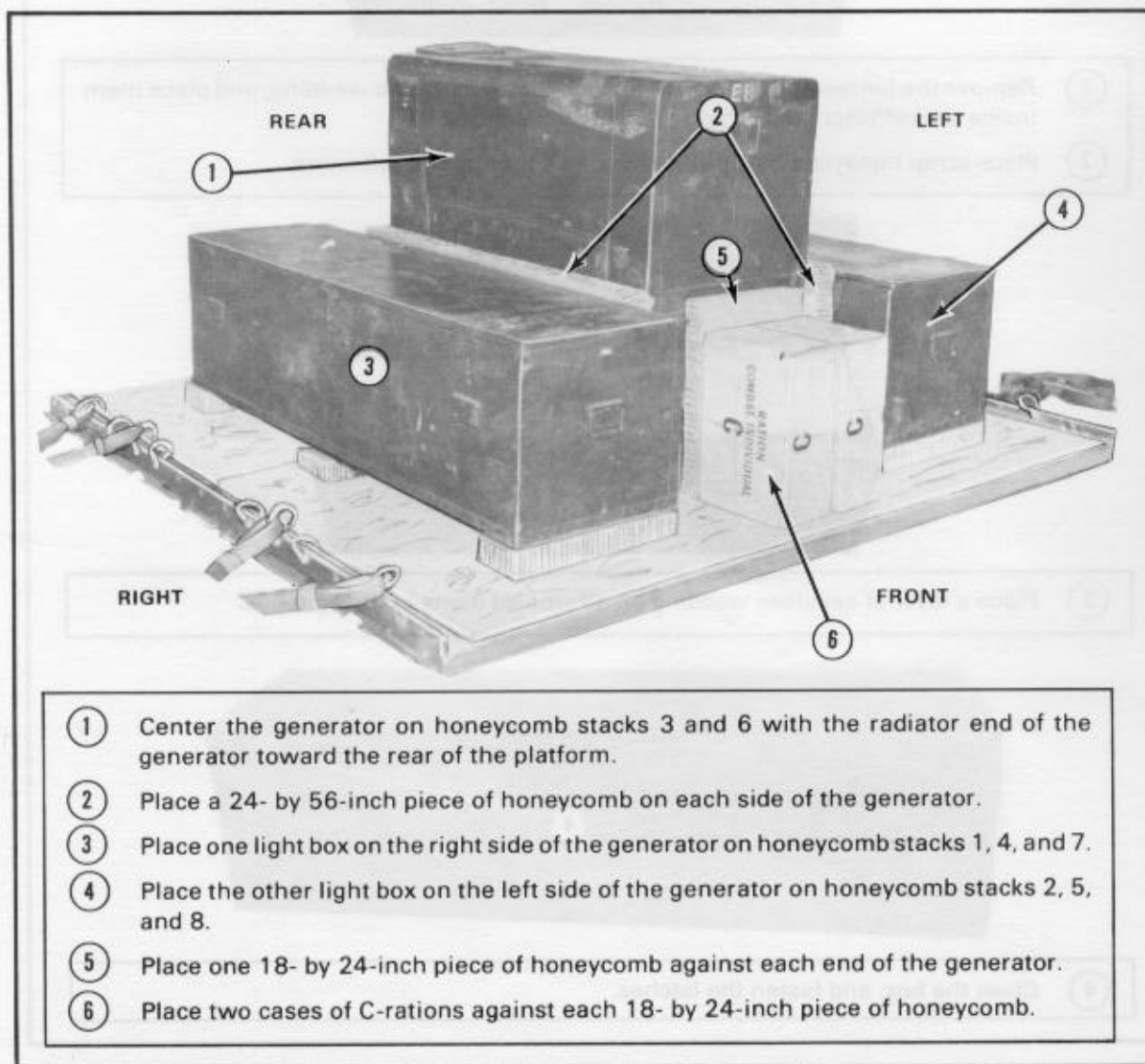
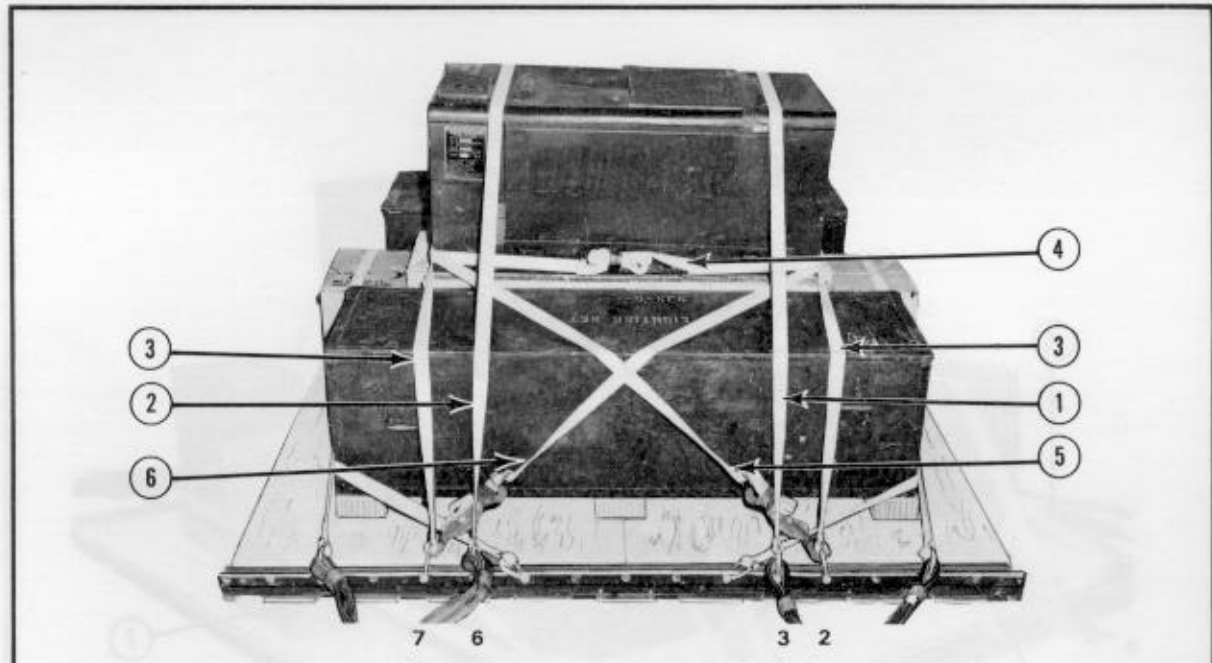

Figure 2-7. Generator, floodlight set, and accompanying load positioned on platform

2-8. Installing Lashings

Use twelve 15-foot tiedown straps, 12 D-rings, and 10 load binders to lash the load to the

platform according to FM 10-500/TO 13C7-1-5 and as shown in figures 2-8 and 2-9 .



Lashing Number	Tiedown Clevis Number	Instructions
1	3 to 3A	Pass the lashing through its own D-ring and over the generator.
2	6 to 6A	Same as lashing 1.
3	2 and 7	Use two 15-foot tiedown straps, two D-rings, and one load binder. Pass one strap through clevis 2 and through its own D-ring. Pass one strap through clevis 7 and through its own D-ring. Fit a D-ring on the free end of each strap, and secure the D-rings on the opposite side of the generator according to FM 10-500/TO 13C7-1-5.
4	2A and 7A	Use two 15-foot tiedown straps, two D-rings, and one load binder. Pass one strap through clevis 2A and through its own D-ring. Pass one strap through clevis 7A and through its own D-ring. Fit a D-ring on the free end of each strap, and secure the D-rings on the opposite side of the generator according to FM 10-500/TO 13C7-1-5.
5	2A and 2	Pass the lashing through its own D-ring at clevis 2A and around the rear of the generator to clevis 2.
6	7A and 7	Pass the lashing through its own D-ring at clevis 7A and around the front of the generator to clevis 7.

Figure 2-8. Lashings 1 through 6 installed

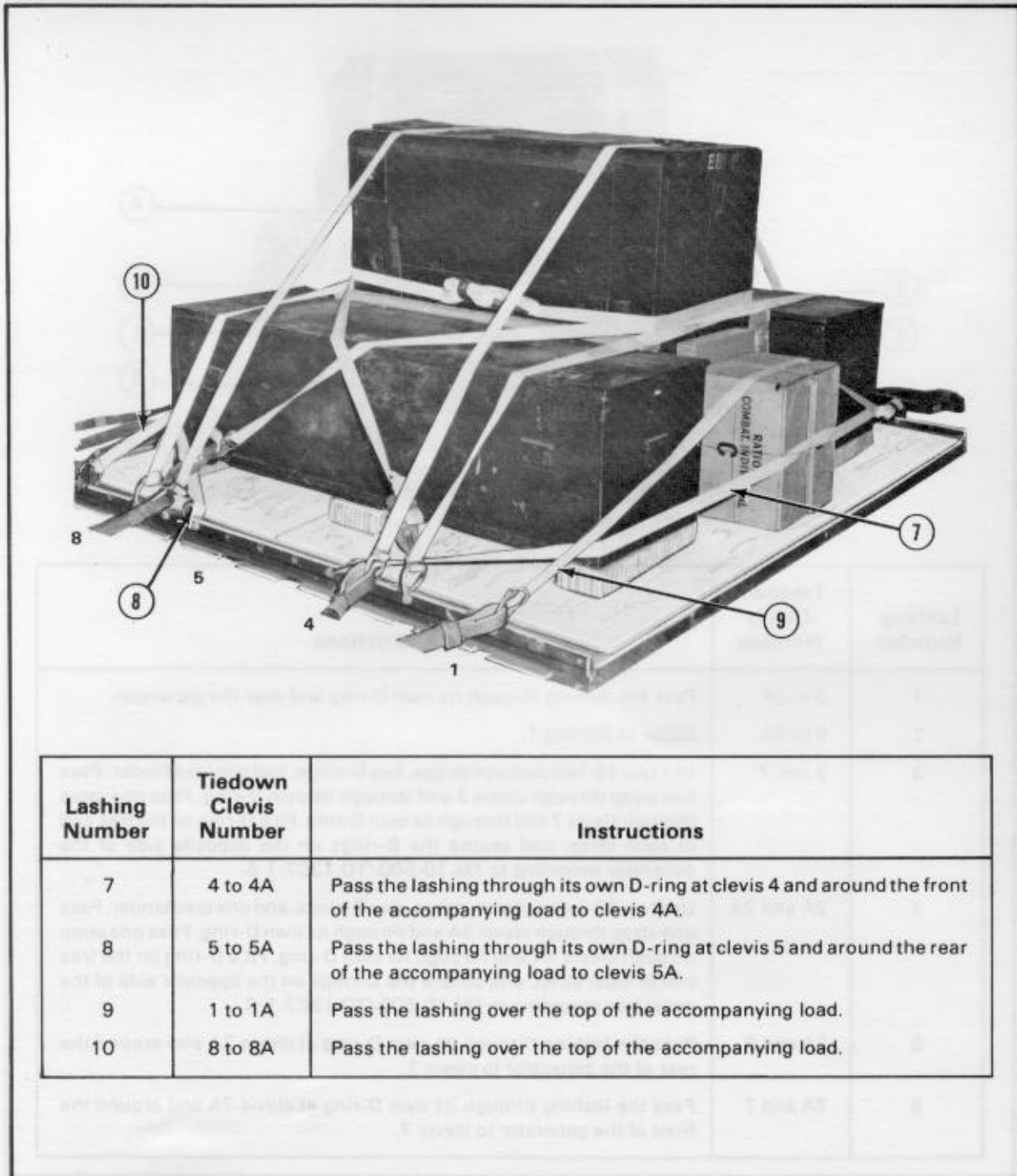

Figure 2-9. Lashings 7 through 10 installed

2-9. Installing Deadman's Tie

Install a deadman's tie on the suspension slings according to FM 10-500/TO 13C7-1-5.

2-10. Stowing Cargo Parachute

Stow one G-11A or G-11B cargo parachute on the load as shown in Figure 2-10.

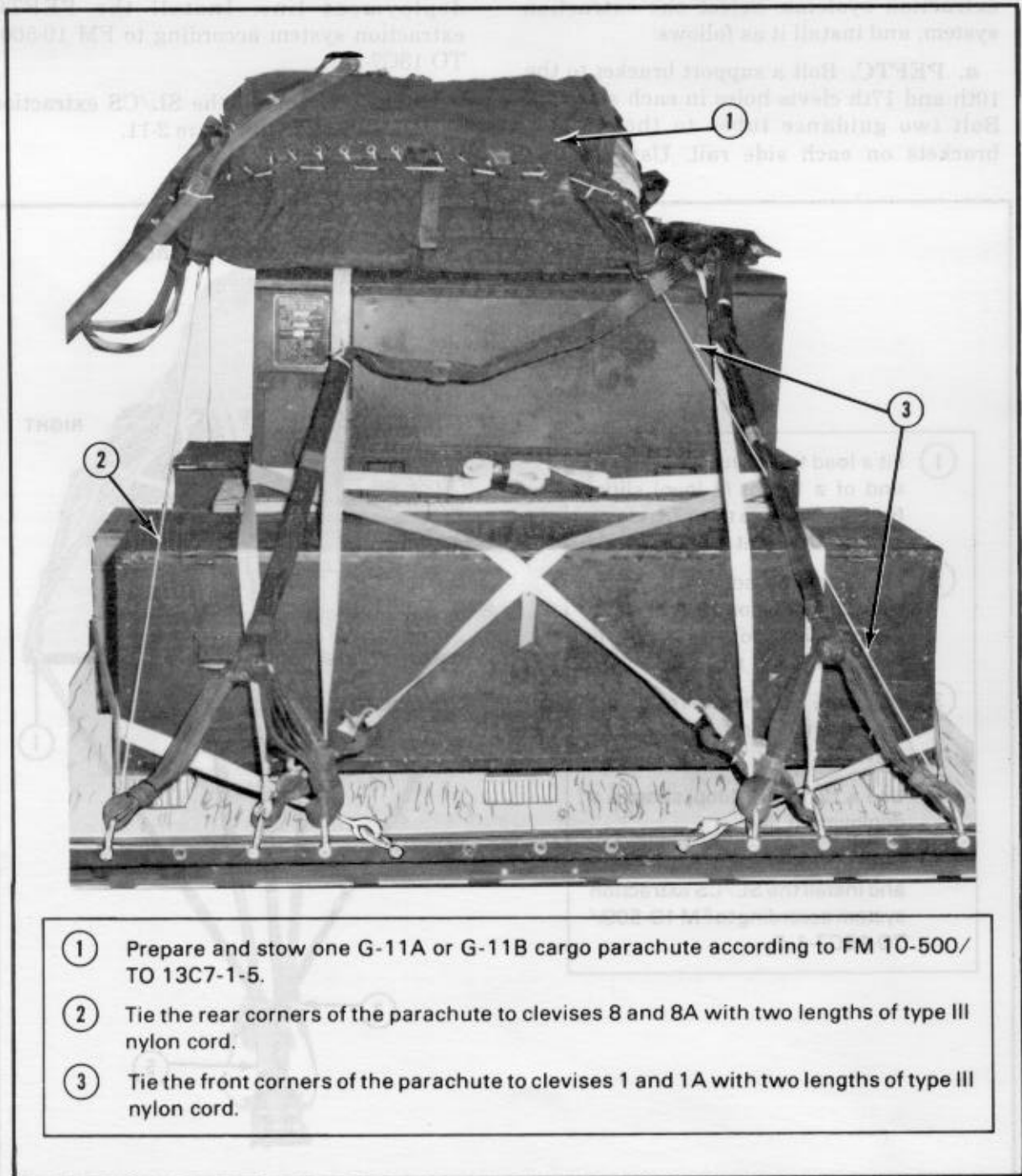

Figure 2-10. Parachute stowed

2-11. Installing Extraction System

Currently, two extraction systems are authorized for use when this load is rigged. These are the PEFTC and the SL/CS extraction systems. Select one extraction system, and install it as follows:

a. PEFTC. Bolt a support bracket to the 10th and 17th clevis holes in each side rail. Bolt two guidance tubes to the support brackets on each side rail. Using the A

mounting holes in the actuators, bolt the actuators to the side rails at the 8th and 9th clevis holes. Use a 16-foot (3-loop) sling as a deployment line. Install the PEFTC extraction system according to FM 10-500/TO 13C7-1-5.

b. SL/CS. Install the SL/CS extraction system as shown in Figure 2-11.

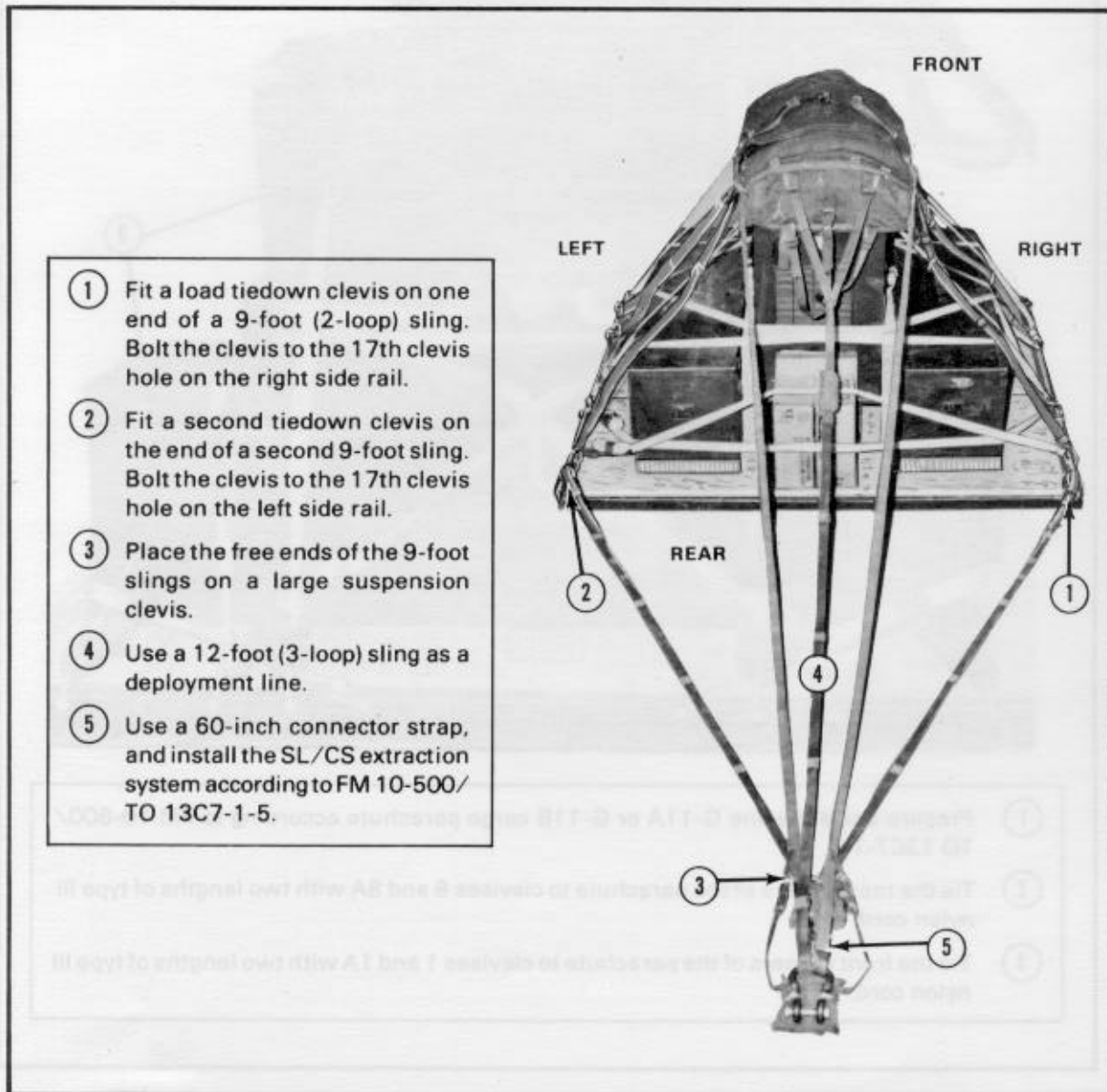

Figure 2-11. SL/CS extraction system installed

2-12. Installing Release System

Prepare and install an M-1 cargo parachute release assembly according to FM 10-500/TO 13C7-1-5 and as shown in Figure 2-12.



- ① Prepare and install an M-1 cargo parachute release assembly according to FM 10-500/TO 13C7-1-5. Place the release assembly on top of the load. Place a 12- by 12-inch piece of honeycomb under the release assembly.
- ② Safety the release assembly according to FM 10-500/TO 13C7-1-5.
- ③ Pull the platform suspension slings taut, and safety the slings to convenient points on the load with lengths of type III nylon cord.

Figure 2-12. The M-1 release assembly installed

2-13. Positioning Extraction Parachute

Position the extraction parachute as described below.

a. C-130 Aircraft. Place a reefed 15-foot cargo extraction parachute on the load for installation in the aircraft.

b. C-141 Aircraft. Place a reefed 15-foot cargo extraction parachute with an adapter web and a continuous 160-foot (1-loop), type XXVI, nylon webbing extraction line on the load for installation in the aircraft.

2-14. Marking Rigged Load

Mark the rigged load according to FM 10-500/TO 13C7-1-5 and as shown in Figure 2-13.

Complete DD Form 1387-2 (Special Handling Data/Certification), and securely attach it to the load. Indicate on DD Form 1387-2 that the generator fuel tank and the battery have been prepared according to AFR 71-4/TM 38-250. If the load varies, the weight, height, center of balance, and parachute requirements must be computed.

Note: When rigging this load for airdrop on a drop zone with ground elevation of 6,000 to 10,000 feet, add 3 inches to the height listed in Figure 2-13.

CAUTION: Make the final rigger inspection required by FM 10-500/TO 13C7-1-5 before the load leaves the rigging site.

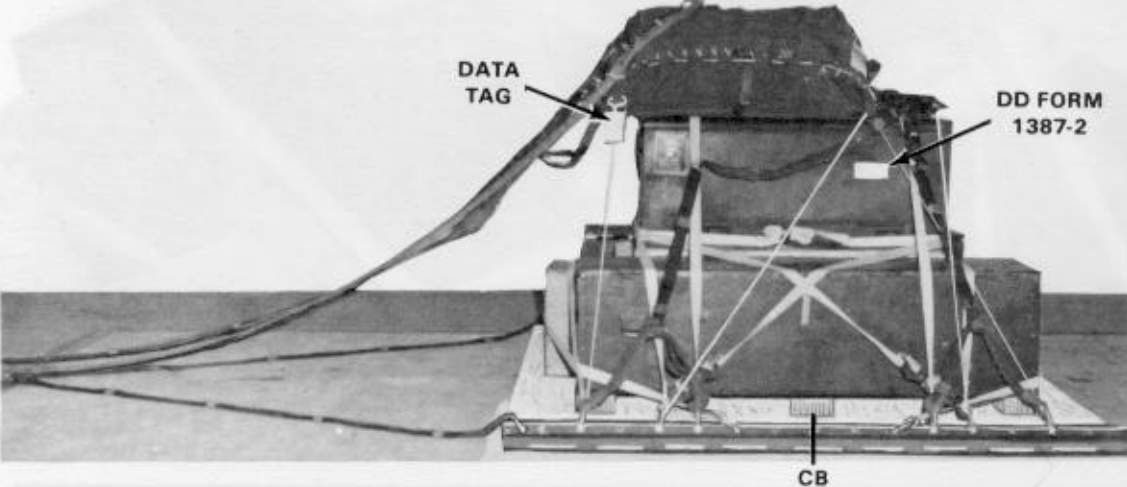

RIGGED LOAD DATA	
Weight	2,520 pounds
Height	69 inches
Width	108 inches
Length	96 inches
CB (from the front edge of the platform)	52 inches
Extraction system (shown)	SL/CS

Figure 2-13. Generator, floodlight set, and accompanying load rigged for low-velocity airdrop

2-15. Equipment Required

The equipment required for rigging this load is listed in Table 2-1.

Table 2-1. Equipment required for rigging generator, floodlight set, and accompanying load

National Stock Number	Item	Quantity
1670-00-040-8215	Adapter web, 36-in (for C-141 aircraft)	1
8040-00-273-8713	Adhesive, paste, 1-gal	As required
1377-00-958-1048	*Cartridge, time-delay, 20-sec (for use w 5,000-lb release)	1
4030-00-090-5354	Clevis assembly, suspension, large	2
4020-00-240-2146	Cord, nylon, type III, 550-lb	As required
1670-00-168-6068	**Coupling, extraction force transfer (platform)	1
1670-00-360-0329	Cover, link (add one for C-141 aircraft)	1
8135-00-664-6958	Cushioning material, packaging, cellulose wadding	As required
8305-00-958-3685	Felt sheet, 1/2-in thick	As required
1670-00-856-0265	Line, extraction, nylon webbing, 60-ft (1-loop), type X <u>OR</u>	1
1670-01-064-4452	Line, extraction, nylon webbing, 60-ft (1-loop), type XXVI (for C-130 aircraft) <u>OR</u>	1
1670-01-107-7652	Line, extraction, nylon webbing, 160-ft (1-loop), type XXVI (for C-141 aircraft)	1
1670-00-783-5988	Link assembly, single, type IV (add one for C-141 aircraft)	1
	Lumber:	
5510-00-220-6146	2- by 4- by 4 7/8-in	1
5510-00-220-6146	2- by 4- by 16-in	1
5510-00-220-6148	2- by 6- by 16-in	1
1670-00-753-3928	Pad, energy-dissipating, honeycomb, 3- by 36- by 96-in:	3 sheets
	6- by 24-in	(6)
	12- by 18-in	(6)
	18- by 24-in	(2)
	24- by 56-in	(2)
	Parachute:	
1670-00-269-1107	Cargo, 100-ft, G-11A <u>OR</u>	1
1670-01-016-7841	Cargo, 100-ft, G-11B	1
1670-01-063-3715	***Cargo, extraction, 15-ft	1
	Platform, airdrop, modular, 8-ft:	
1670-00-893-1631	Clevis, load tiedown	18
1670-00-893-1624	Panel	2
1670-00-893-1625	Rail, platform, side, 8-ft	2

Table 2-1. Equipment required for rigging generator, floodlight set, and accompanying load (continued)

National Stock Number	Item	Quantity
5320-00-893-1632	Rivet, blind-drive type, 1/4-in diam	32
5530-00-128-4981	Plywood:	
	3/4- by 4- by 16-in	1
	3/4- by 4- by 18 1/4-in	2
	3/4- by 8- by 16-in	1
	3/4- by 12- by 18-in	2
	3/4- by 48- by 96-in	2
1670-00-168-6070	Release, cargo parachute, M-1 <u>OR</u>	1
1670-00-799-8494	*Release, 5,000-lb-capacity cargo parachute	1
	Slings, cargo, airdrop:	
	For 5,000-lb releases:	
1670-00-753-3788	3-ft (3-loop), type X <u>OR</u>	1
1670-00-062-6301	3-ft (2-loop), type XXVI	1
	For platform suspension:	
1670-00-753-3788	3-ft (3-loop), type X <u>OR</u>	4
1670-01-062-6301	3-ft (2-loop), type XXVI	4
1670-00-753-3790	9-ft (2-loop), type X <u>OR</u>	4
1670-01-062-6304	9-ft (2-loop), type XXVI	4
	For deployment line:	
1670-00-823-5042	16-ft (3-loop), type X <u>OR</u>	1
1670-01-063-7761	16-ft (2-loop), type XXVI	1
7110-00-266-5016	Tape, adhesive, 2-in	As required
1670-00-937-0271	Tiedown assembly, 15-ft	12
8305-00-268-2411	Webbing, cotton, 80-lb	As required
8305-00-082-5752	Webbing, nylon, tubular, 1/2-in	As required
<i>*This item will not be used with the G-11B cargo parachute.</i>		
<i>**When this item is not available, the following items are required for the SL/CS:</i>		
4030-00-090-5354	Clevis assembly, suspension, large	2
1670-00-783-5988	Link assembly, single, type IV	1
	Slings, cargo, airdrop:	
1670-00-753-3788	3-ft (3-loop), type X <u>OR</u>	1
1670-01-062-6301	3-ft (2-loop), type XXVI	1
1670-00-823-5041	12-ft (3-loop), type X <u>OR</u>	1
1670-01-062-6303	12-ft (2-loop), type XXVI	1
1670-00-998-0117	Static line, cargo parachute, breakaway-type, w release knife and clevis	2
1670-00-738-5878	Strap, connector, 60-in	1
<i>***Install the extraction parachute according to these types of aircraft:</i>		
1. C-130. Use the reefed 15-foot extraction parachute on loads rigged for drop from a C-130 aircraft.		
2. C-141. Use the reefed 15-foot extraction parachute on loads rigged for drop from a C-141 aircraft. In addition, the parachute needs a 36-inch adapter web and a continuous 160-foot (1-loop), type XXVI, nylon line.		

GLOSSARY

ACB	attitude control bar	LAPES	low-altitude parachute-extraction system
AFR	Air Force regulation	lb	pound
AFTO	Air Force technical order	PEFTC	platform extraction force transfer coupling
attn	attention	sec	second
CB	center of balance	SL/CS	static line/connector strap
DA	Department of the Army	TM	technical manual
DC	District of Columbia	TO	technical order
DD	Department of Defense	TRADOC	United States Army Training and Doctrine Command
diam	diameter	TX	Texas
FM	field manual	US	United States (of America)
ft	foot/feet	VA	Virginia
gal	gallon	w	with
HQ	headquarters		
IL	Illinois		
in	inch		
LAPE	low-altitude parachute-extraction		

REFERENCES

AFR 71-4/TM 38-250	Packaging and Materials Handling: Preparation of Hazardous Materials for Military Air Shipment
FM 10-500/TO 13C7-1-5	Airdrop of Supplies and Equipment: Rigging Airdrop Platforms
FM 10-553/TO 13C7-18-41	Airdrop of Supplies and Equipment: Rigging Ammunition
TM 5-6115-332-14/ TO 35C2-3-424-1	Operator, Organizational, Intermediate (Field), Direct Support, General Support, and Depot Level Maintenance Manual: Generator Set, Tactical, Gasoline Engine: Air Cooled, 5 KW, AC, 120/240V Single Phase, 120/208V 3 Phase, Skid Mounted, Tubular Frame (Less Engine) (Military Design, DOD Models MEP-071A & MEP-022A)
TM 10-1670-208-20&P/ TO 13C3-4-12	Organizational Maintenance Manual Including Repair Parts and Special Tools List for Platforms, Type II Modular and LAPES/Airdrop Modular
TM 10-1670-215-23/ TO 13C5-1-102	Organizational and DS Maintenance Manual Including Repair Parts and Special Tools List for Parachute, Cargo Types: 12-Foot-Diameter High-Velocity, G-13 24-Foot-Diameter, 26-Foot-Diameter High-Velocity, G-14 34-Foot-Diameter, 38-Foot-Diameter RCAT, G-12C and G-12D 64-Foot Diameter, G-11A 100-Foot-Diameter, 15-Foot-Diameter Extraction, 22-Foot-Diameter Extraction, 28-Foot-Diameter Extraction, and 3-Foot-Square Pilot
DD Form 1387-2	Special Handling Data/Certification

FM 10-535/TO 13C7-40-11

14 NOVEMBER 1985

By Order of the Secretaries of the Army and the Air Force:

E. C. MEYER

*General, United States Army
Chief of Staff*

Official:

MILDRED E. HEDBERG

*Brigadier General, United States Army
The Adjutant General*

DISTRIBUTION:

Active Army, USAR, and ARNG: To be distributed in accordance with DA Form 12-11A, Requirements for Airdrop of Supplies and Equipment (Qty rqr block no. 228).

Additional copies may be requisitioned from the US Army Adjutant General Publications Center, 2800 Eastern Boulevard, Baltimore, MD 21220-2896.